

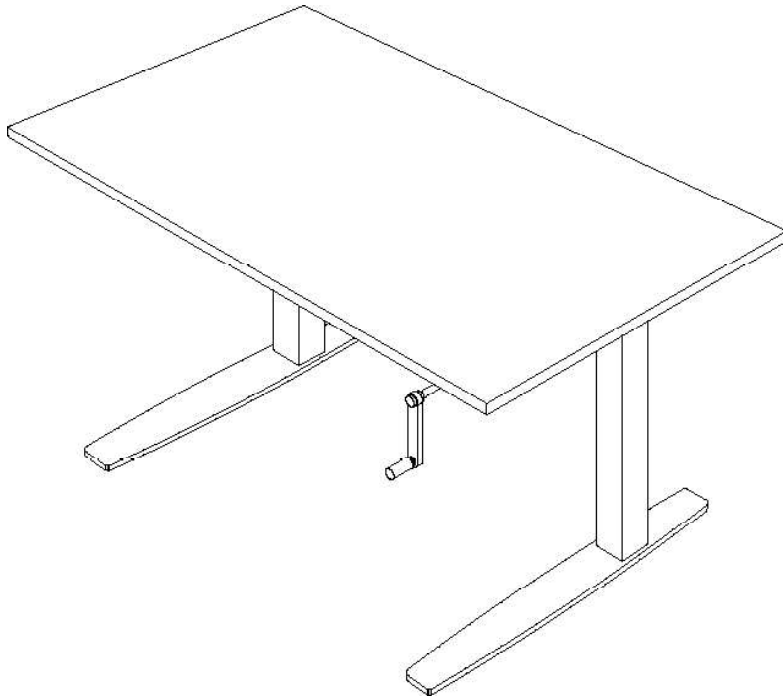

# EQUITY SERIES UNDERMOUNT CRANK

*Computer workstation  
with hand-crank adjustment*



**An ergonomic workstation with a clean modern look, smooth hand-crank adjustment, and variable sit-to-stand height adjustment.**

**FEATURES:**

- Single surface workstation with vertical height adjustment for individual positioning or multi-user environments
- Easy to turn hand-crank adjustment
- Hand-crank is positioned under the table and retracts out of the way
- Meets or exceeds ANSI/BIFMA standard, BSR/HFES 100 standard, and ANSI A 117.1 (wheelchair accessibility) standard
- Durable laminate top

**TECHNICAL DATA:**

- See chart for standard dimensions
- Custom workstation top sizes and finishes available
- Vertical adjustment range 24"-38" or 27-45, 6 cranks per inch
- Load capacity 225 lbs.
- 14 Gauge Steel for telescoping leg. US Made Plate steel 0.5" thick for feet and support brackets
- Tight tolerances produce a stable adjustment in all positions

MODEL	DIMENSIONS	ADJUSTMENT RANGE "	START / END HEIGHT "	LEG SPAN
EQ 3624 UC	36" X 24"	14 or 18	24-38 or 27-45	30"
EQ 3630 UC	36" X 30"	14 or 18	24-38 or 27-45	30"
EQ 4224 UC	42" X 24"	14 or 18	24-38 or 27-45	30"
EQ 4230 UC	42" X 30"	14 or 18	24-38 or 27-45	30"
EQ 4824 UC	48" X 24"	14 or 18	24-38 or 27-45	38"
EQ 4830 UC	48" X 30"	14 or 18	24-38 or 27-45	38"
EQ 6024 UC	60" X 24"	14 or 18	24-38 or 27-45	50"
EQ 6030 UC	60" X 30"	14 or 18	24-38 or 27-45	50"
EQ 7224 UC	72" X 24"	14 or 18	24-38 or 27-45	57"
EQ 7230 UC	72" X 30"	14 or 18	24-38 or 27-45	57"





**POPULAS**  
furniture by AD·AS

**EQUITY SERIES  
UNDERMOUNT CRANK**  
Dimensions

**EQ 3624 UC & EQ 3630 UC**

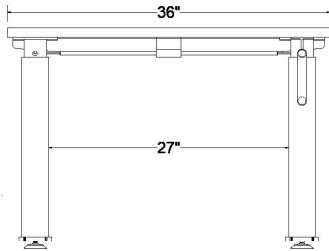

Front View

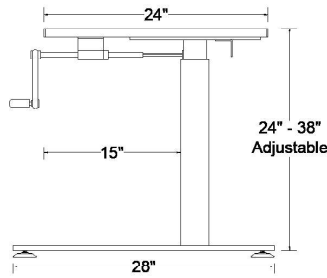

Side View

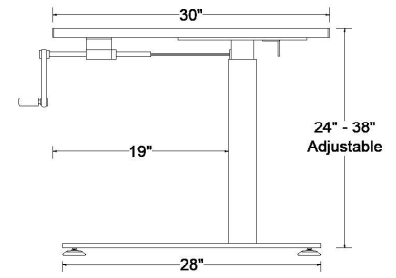

Side View

**EQ 4224 UC & EQ 4230 UC**

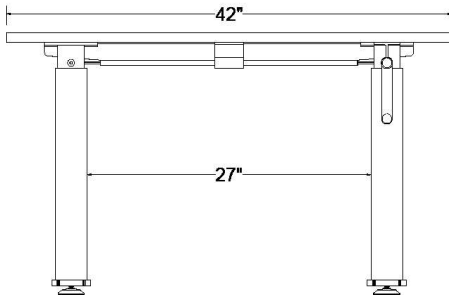

Front View

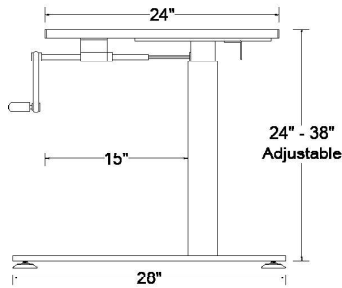

Side View

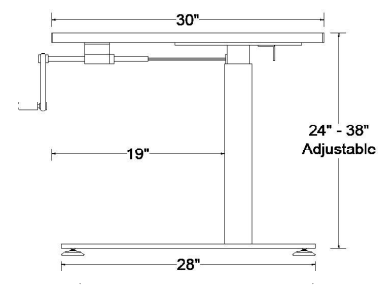

Side View

**EQ 4824 UC & EQ 4830 UC**

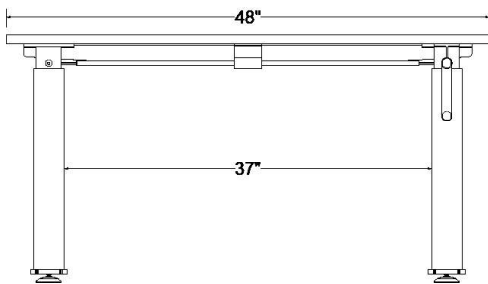

Front View

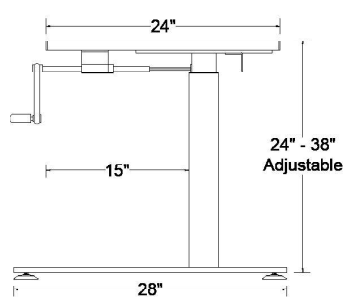

Side View

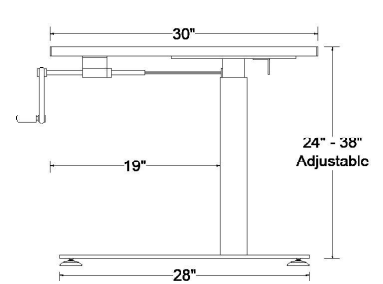

Side View



**POPULAS**  
furniture by AD·AS

**EQUITY SERIES  
UNDERMOUNT CRANK**  
Dimensions

**EQ 6024 UC & EQ 6030 UC**

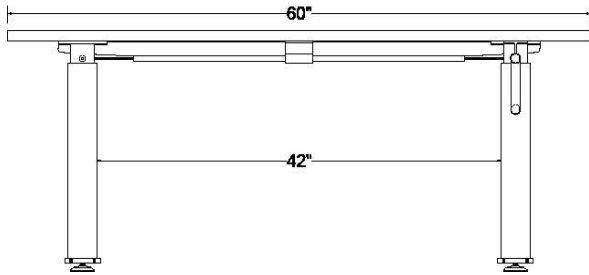

Front View

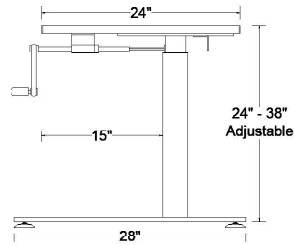

Side View

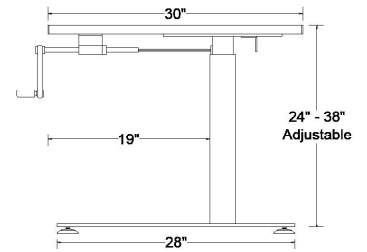

Side View

**EQ 7224 UC & EQ 7230 UC**

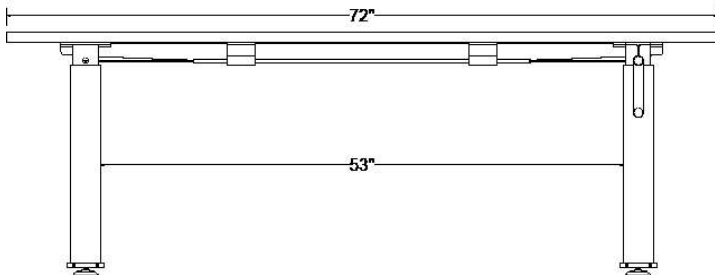

Front View

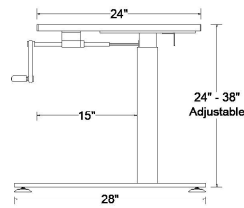

Side View

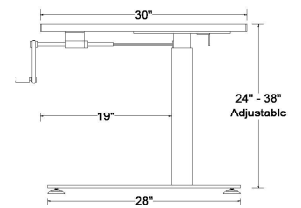

Side View