

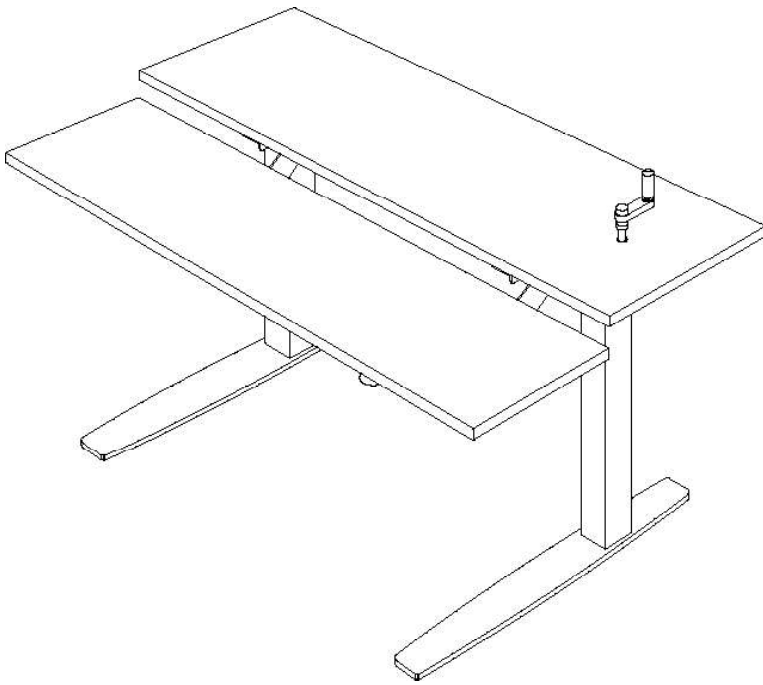

**EQUITY SERIES
KEYBOARD LIFT**

*Bi-level workstation
with hand-crank adjustment*



An ergonomic workstation with a clean modern look, smooth hand-crank adjustment, and variable sit-to-stand height adjustment.

FEATURES:

- Front and rear worksurfaces adjust independently for optimal ergonomics, individual positioning, or multi-user environments
- Lift-N-Lock front surface.
- Top crank actuated for rear work surface with under work surface handle storage
- Durable laminate top

TECHNICAL DATA:

- See chart for standard dimensions
- Front surface adjustment range 20"-45" (4" below, 7" above rear surface), with 15' +/- tilt
- Vertical adjustment range 24"-38" or 27-45, 6 cranks per inch
- Load Capacity 225 lbs. rear surface
- Load Capacity 50 lbs. front surface
- 14 Guage Steel for telescoping leg. US Made Plate steel 0.5" thick for feet and support brackets
- Tight tolerances produce a stable adjustment in all positions

MODEL	FRONT/REAR DIMENSIONS	OVERALL DIMENSIONS	ADJUSTMENT RANGE "	START / END HEIGHT "	LEG SPAN
EQ 361416 KBL	36" X 14" 36" X 16"	36" X 31"	14 or 18	24-38 or 27-45	30"
EQ 421416 KBL	42" X 14" 42" X 16"	42" X 31"	14 or 18	24-38 or 27-45	30"
EQ 481416 KBL	48" X 14" 48" X 16"	48" X 31"	14 or 18	24-38 or 27-45	38"
EQ 601416 KBL	60" X 14" 60" X 16"	60" X 31"	14 or 18	24-38 or 27-45	50"
EQ 721416 KBL	72" X 14" 72" X 16"	72" X 31"	14 or 18	24-38 or 27-45	57"





**EQUITY SERIES
KEYBOARD LIFT**
Dimensions

EQ 361416 KBL

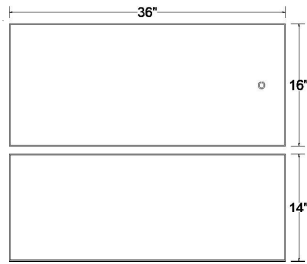

Top View

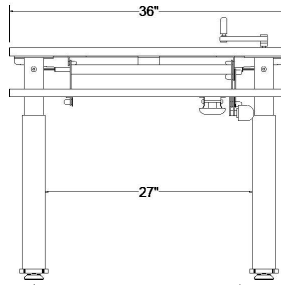

Front View

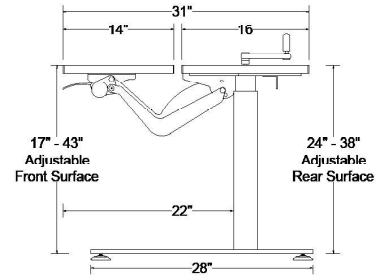

Side View

EQ 421416 KBL

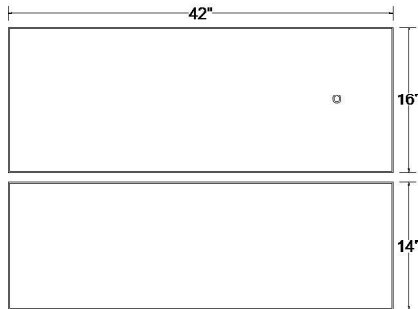

Top View

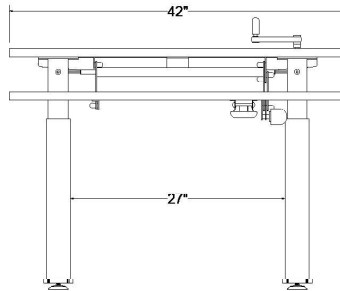

Front View

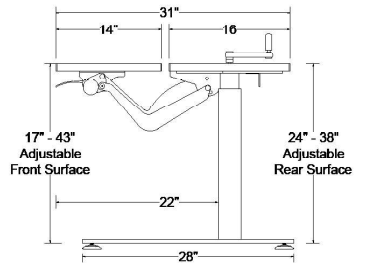

Side View

EQ 481416 KBL

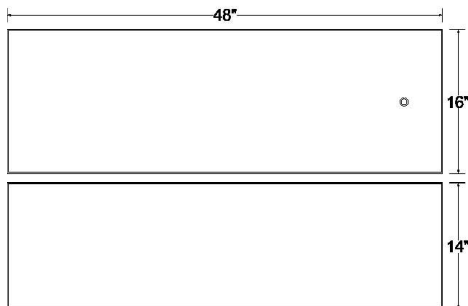

Top View

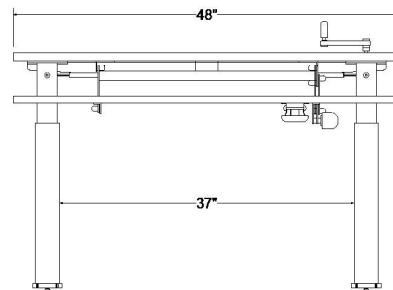

Front View

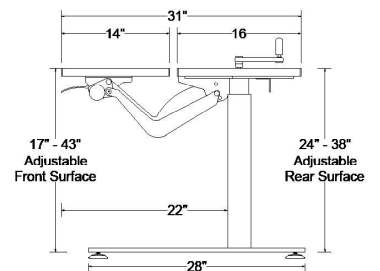

Side View



POPULAS
furniture by AD·AS

**EQUITY SERIES
KEYBOARD LIFT**
Dimensions

EQ 601416 KBL

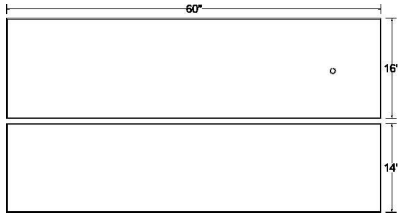

Top View

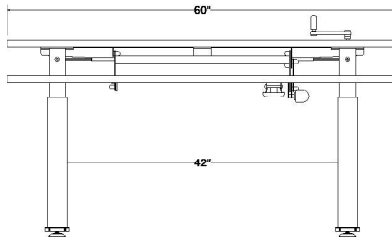

Front View

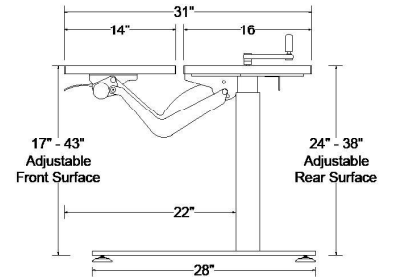

Side View

EQ 721416 KBL

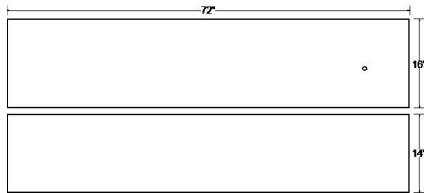

Top View

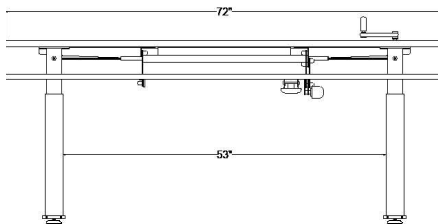

Front View

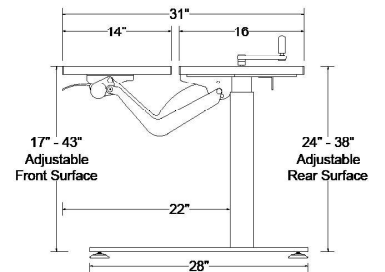

Side View